



novosan

LAUFEN



8.9496.7.000.000.1



7 612738 340056

10/04/15 8.9496.7.000.000.1 KPA

1 x

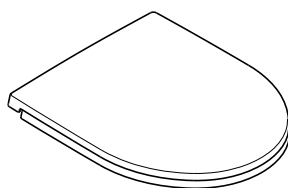

2 x

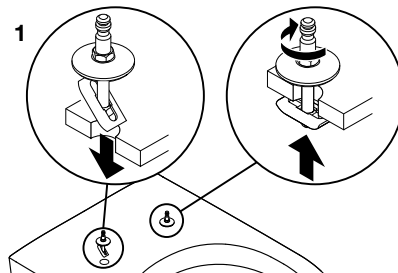
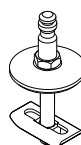

2

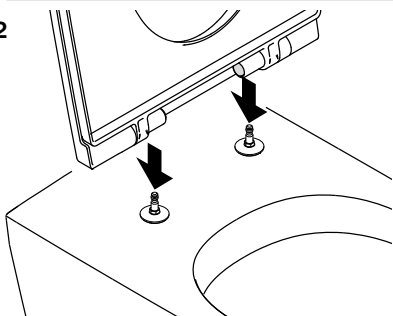

3

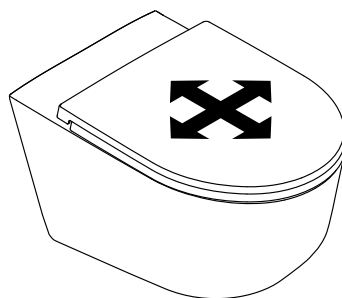

4

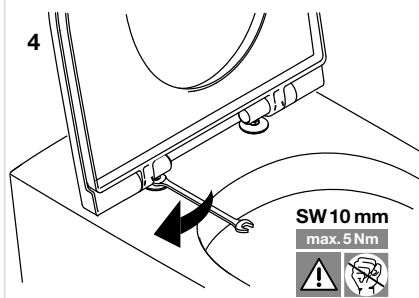

- Demontage
- Démontage
- Smontaggio
- Disassembly
- Desmontaje
- Demonteren
- Demontáž
- Išardymas
- Demontaž
- Leszerelés
- Демонтаж
- Демонтаж

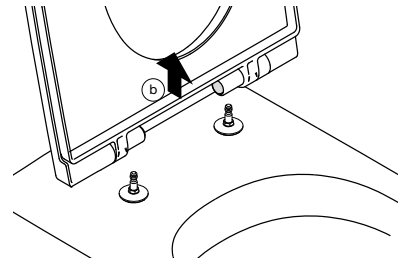
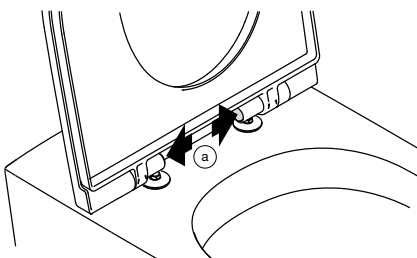

Novosan Oy

asiakaspalvelu@novosan.fi p. 09-478 922 31 myynti@novosan.fi p. 09- 425 770 20

www.novosan.fi